



**nvc**®

**Energy-saving  
Flexibility  
Long Life**

***FLEX LED STRIP***

**An Alternative with a Big Effect**



# FLEX LED STRIP

FLEX LED Strip provided by NVC Lighting offers high brightness and superior technology in compact, high-flux LED units. Slim NVC FLEX LED Strip is capable to be fit anywhere and can provide exceptional applications.

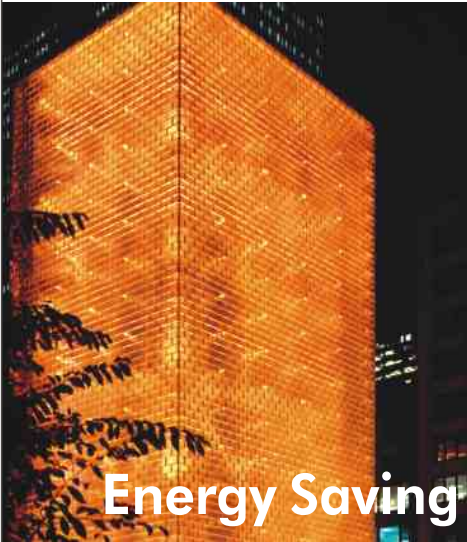

## ■ Features

- Can be divided into units of 3 LEDs or multiples thereof with no loss of function for the parts.
- Field cut available to achieve a customized fit with compact dimensions and cutting options.
- Flexible 3D mounting possible;  
Flexible board with double-sided adhesive tape for simple mounting.
- Long lifespan: up to 50,000 hours when temperature at Tc point is maintained at or below 40°C. minimizing maintenance frequency.
- A variety of colours to fit many different architectural applications.

## ■ IP Rating

Different protection against ingress is provided to match needs of customer:  
Ribbon, Dropper, Silicone, Silicone & Glue-filled.



Ribbon

**A (IP20)**



Dropper

**B (IP44)**

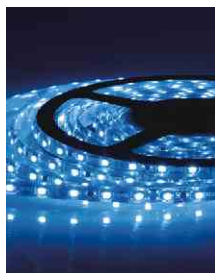

Silicone

**C (IP65)**



Silicone & Glue-filled

**D (IP68)**





## Technical Specifications

### Single Colour Flex LED Strip

Input: DC 12V Current/Per Unit: 20mA

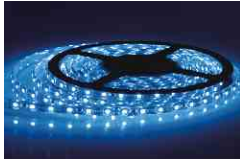

Model	Colour	Power/m	Lumens/m	LED QTY/m
DL-3528R60R-12V	Red	4.8 W	90 lm	60
DL-3528Y60R-12V	Yellow	4.8 W	90 lm	60
DL-3528B60R-12V	Blue	4.8 W	60 lm	60
DL-3528G60R-12V	Green	4.8 W	240 lm	60
DL-3528W60R-12V	Day Light	4.8 W	300 lm	60
DL-3528W W60R-12V	Warm White	4.8 W	240 lm	60
DL-3528R120R-12V	Red	9.6 W	270 lm	120
DL-3528Y120R-12V	Yellow	9.6 W	270 lm	120
DL-3528B120R-12V	Blue	9.6 W	180 lm	120
DL-3528G120R-12V	Green	9.6 W	480 lm	120
DL-3528W120R-12V	Day Light	9.6 W	600 lm	120
DL-3528WW120R-12V	Warm White	9.6 W	480 lm	120

\* Warm White (3000k) Day Light (6500k)

### High Output Flex LED Strip

Input: DC 12V Current/Per Unit: 20mA

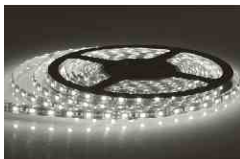

Model	Colour	Power/m	Lumens/m	LED QTY/m
DL-5050R30R-12V	Red	7.2 W	135 lm	30
DL-5050Y30R-12V	Yellow	7.2 W	135 lm	30
DL-5050B30R-12V	Blue	7.2 W	90 lm	30
DL-5050G30R-12V	Green	7.2 W	360 lm	30
DL-5050W30R-12V	Day Light	7.2 W	480 lm	30
DL-5050WW30R-12V	Warm White	7.2 W	350 lm	30
DL-5050RGB30R-12V	RGB	7.2 W		30
DL-5050R60R-12V	Red	14.4 W	180 lm	60
DL-5050Y60R-12V	Yellow	14.4 W	180 lm	60
DL-5050B60R-12V	Blue	14.4 W	120 lm	60
DL-5050G60R-12V	Green	14.4 W	720 lm	60
DL-5050W60R-12V	Day Light	14.4 W	960 lm	60
DL-5050WW60R-12V	Warm White	14.4 W	900 lm	60
DL-5050RGB60R-12V	RGB	14.4 W		60

\* Warm White (3000k) Day Light (6500k)

## Dimensions

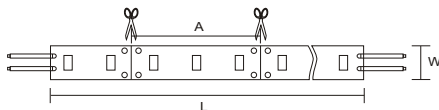

Model	A	W	L
DL-3528X60R-12V	50mm	8mm	5m
DL-3528X120R-12V	25mm	8mm	5m
DL-5050X30R-12V	100mm	10mm	5m
DL-5050X60R-12V	50mm	10mm	5m

# FLEX LED STRIP

## Optional Accessories

Model	Specification	Input	Power
3528	60LED/M, 5M/ROLL	DC12V	24W
3528	120LED/M, 5M/ROLL	DC12V	48W
5050	30LED/M, 5M/ROLL	DC12V	36W
5050	60LED/M, 5M/ROLL	DC12V	72W

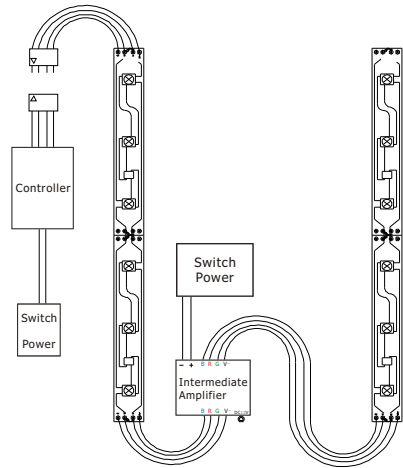
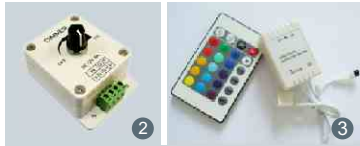

- ① Control Gear(Special Transformer)
- ② Dimmer
- ③ Controller(24 keys)

The connecting system provides simple connection of LED modules with feeders and cable connectors. Tight spaces, extensive applications and complex structures are no problem at all.

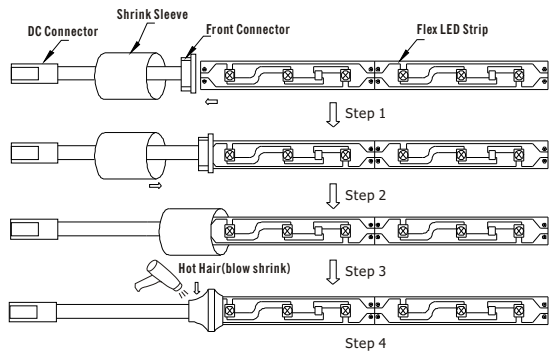

- ④ Head cap/End cap
- ⑤ Shrink Sleeve
- ⑥ Clips
- ⑦ Intermediate Connector
- ⑧ RGB Connector in front

# FLEX LED STRIP



## Applications:

- For directional luminaires, illuminated signage and display cabinet lighting
- Back lighting of complex contours
- For decorative applications
- For coving, counters or handrails and additional illumination
- In illuminated advertising

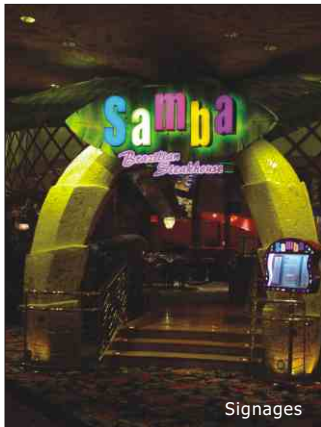

Signages



Effect Lighting



Building



Landscape



Decorative



Decorative

## Package:

5 meter strip in one reel, one reel in one anti-static bag, 25 bags put into one cartoon.



5 meter/reel



1 reel/pack



20 bags/CTN



# Colorful



## About NVC Lighting

NVC Lighting Technology Corporation is now the largest lighting manufacturer in China. We have a broad range of products for professional and domestic use, supported by extensive research, development and manufacturing facilities.

Our product ranges includes commercial, office, outdoor and residential lighting, plus lamps and gear and a full range of electrical accessories. NVC was founded in 1998 and quickly became famous for its quick reactions to market changes. Such reactions resulted in a consistent and rapid growth in sales, which reached 600 million USD in 2009.

We have now started to market our products under the NVC brand outside China. Operating through a network of 1500 distributors and 2500 exclusive retail outlets in China and overseas NVC is now active throughout Asia, the Middle East, Africa, Europe, Australia and Latin America.

Thanks to investment in 2006 from Softbank & Goldman Sachs, and our recent flotation on the Hong Kong stock exchange, NVC has been able to recruit senior figures from the lighting industry and elsewhere to build a strong management team. This, coupled with a solid capital structure, has enabled NVC to accelerate its rate of business development both in China and overseas.



### NVC LIGHTING TECHNOLOGY CORPORATION

Add: NVC Industrial Park, Ruhu, Huizhou, Guangdong, P.R. China 516021

Tel: +86-752-2786890 2786891 2786887

Fax: +86-752-2786892 2786689

E-mail: [oversea01@nvc-lighting.com](mailto:oversea01@nvc-lighting.com) [oversea20@nvc-lighting.com](mailto:oversea20@nvc-lighting.com)

Http: [www.nvc-lighting.com](http://www.nvc-lighting.com)

50001471